







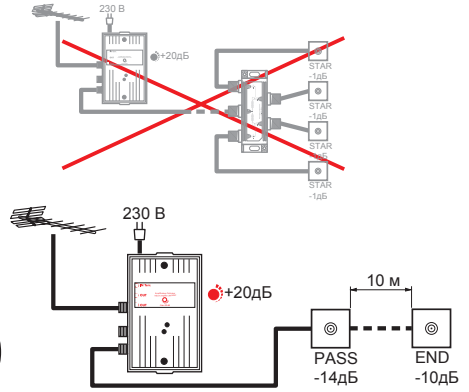
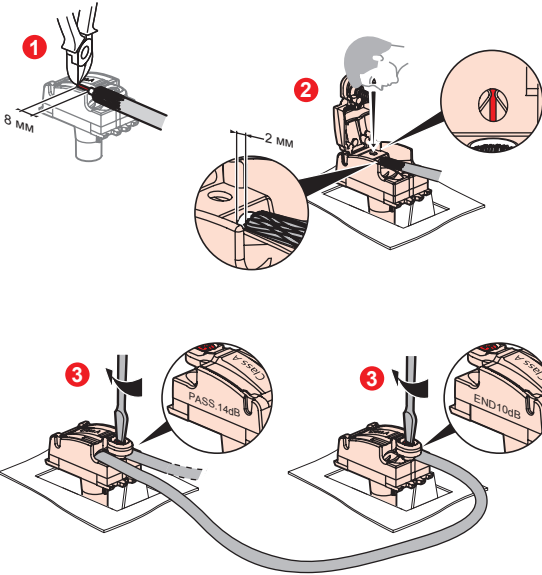

**B** 6 738 60 / 61 / 62 / 63  
6 738 70 / 71 / 72 / 73

			
6 738 60 / 61 / 62 / 63	PASS	14дБ (4-862МГц)	—
6 738 70 / 71 / 72 / 73	END	10дБ (4-862МГц)	—

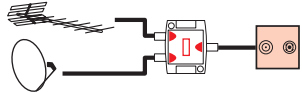

**C** 6 738 80 / 81 / 82 / 83

				
		1.5дБ (4-2400МГц)	2дБ (4-2400МГц)	500мА

